

PROBLEM 01

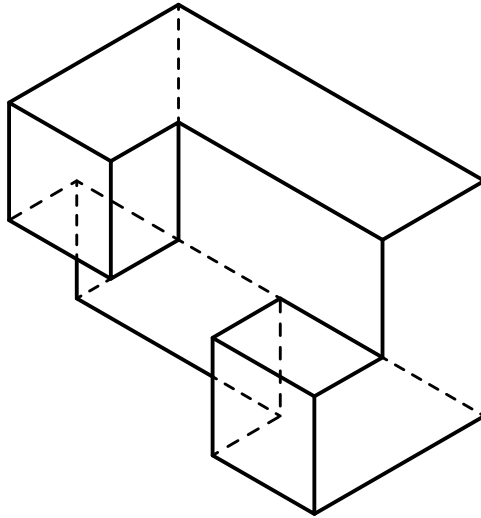

PROBLEM 02

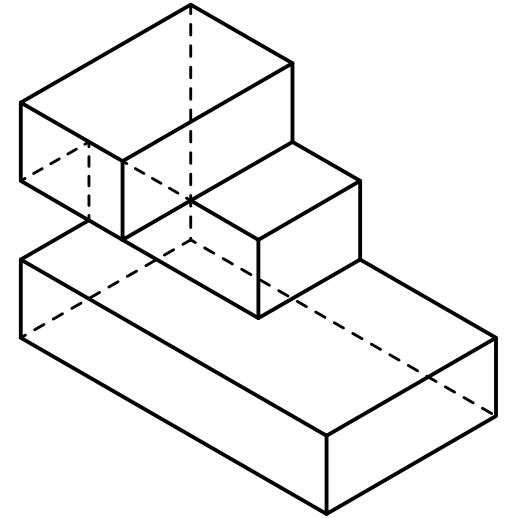

PROBLEM 03

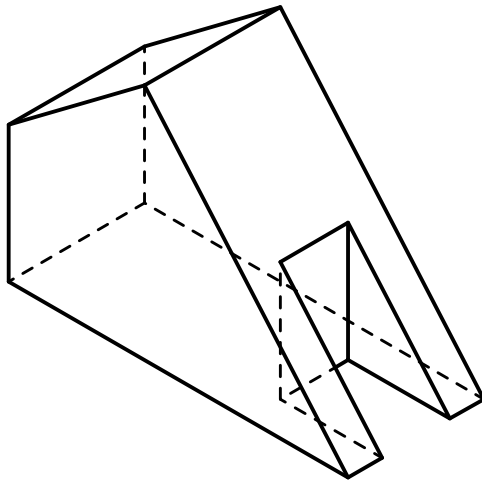

PROBLEM 04

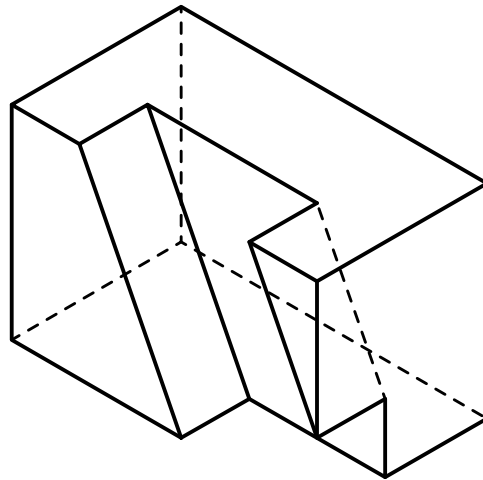

PROBLEM 05

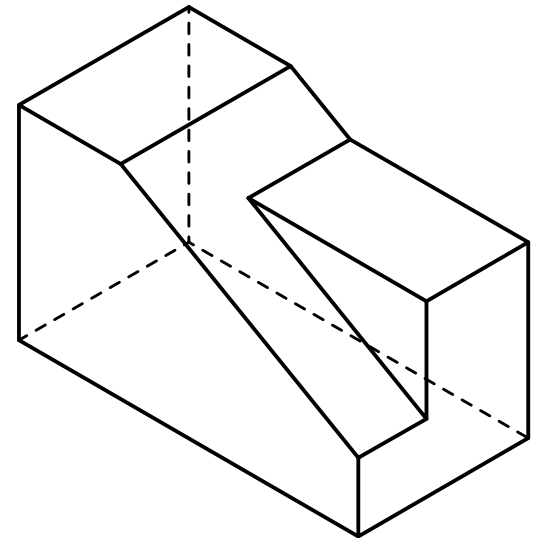

PROBLEM 06

**COMMUNITY COLLEGE
OF ALLEGHENY COUNTY**

COURSE: CAD APPLICATIONS

DRAWN
BY:

STUDENT'S NAME

DATE:

DATE

FILE
NAME: FILE NAME

PART
NAME:

ASSIGNMENT #3

SCALE:

SCALE