

PROBLEM 04

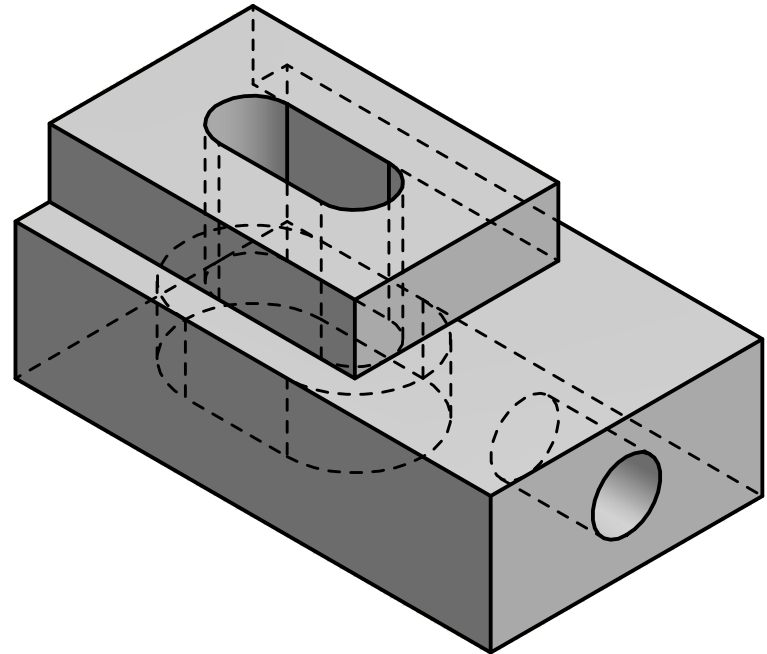

PROBLEM 05

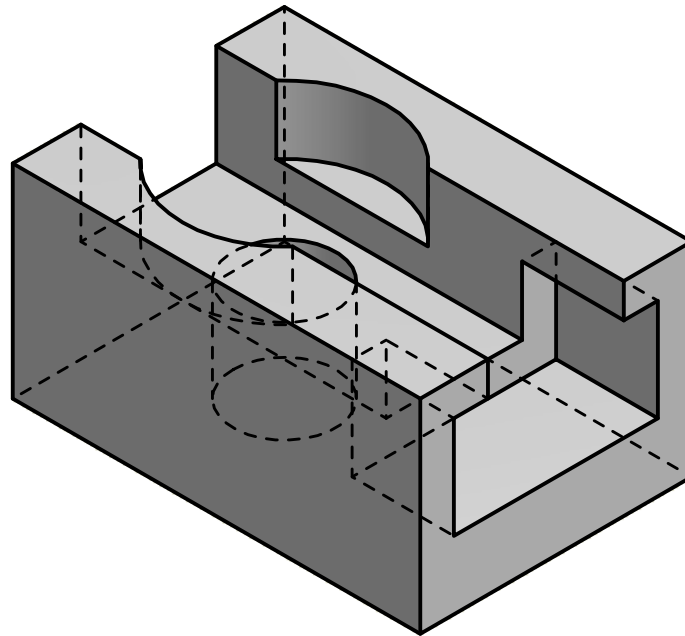

PROBLEM 06

**COMMUNITY COLLEGE
OF ALLEGHENY COUNTY**

COURSE: MECHANICAL DRAWING

FILE NAME: FILE NAME

DRAWN BY:

PART NAME:

STUDENT'S NAME

WORKSHEET 01

DATE:

SCALE:

DATE

SCALE